

# BACHMANN®

45239 KNAPFORD STATION

## Platform Assembly

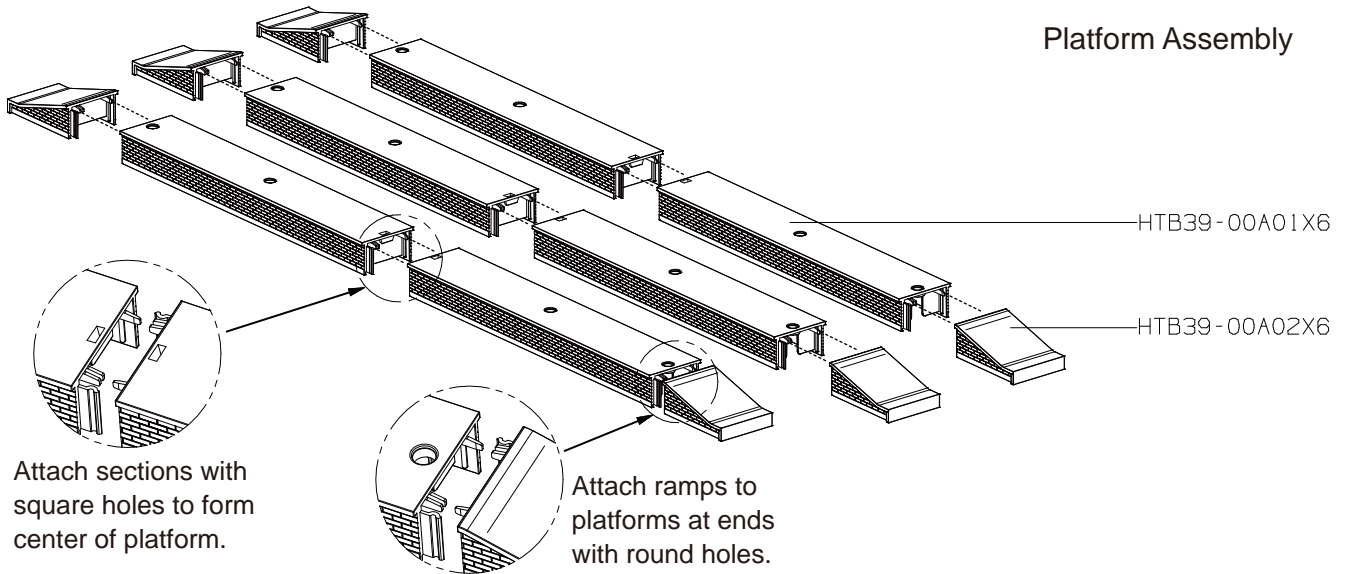

## Column Assembly

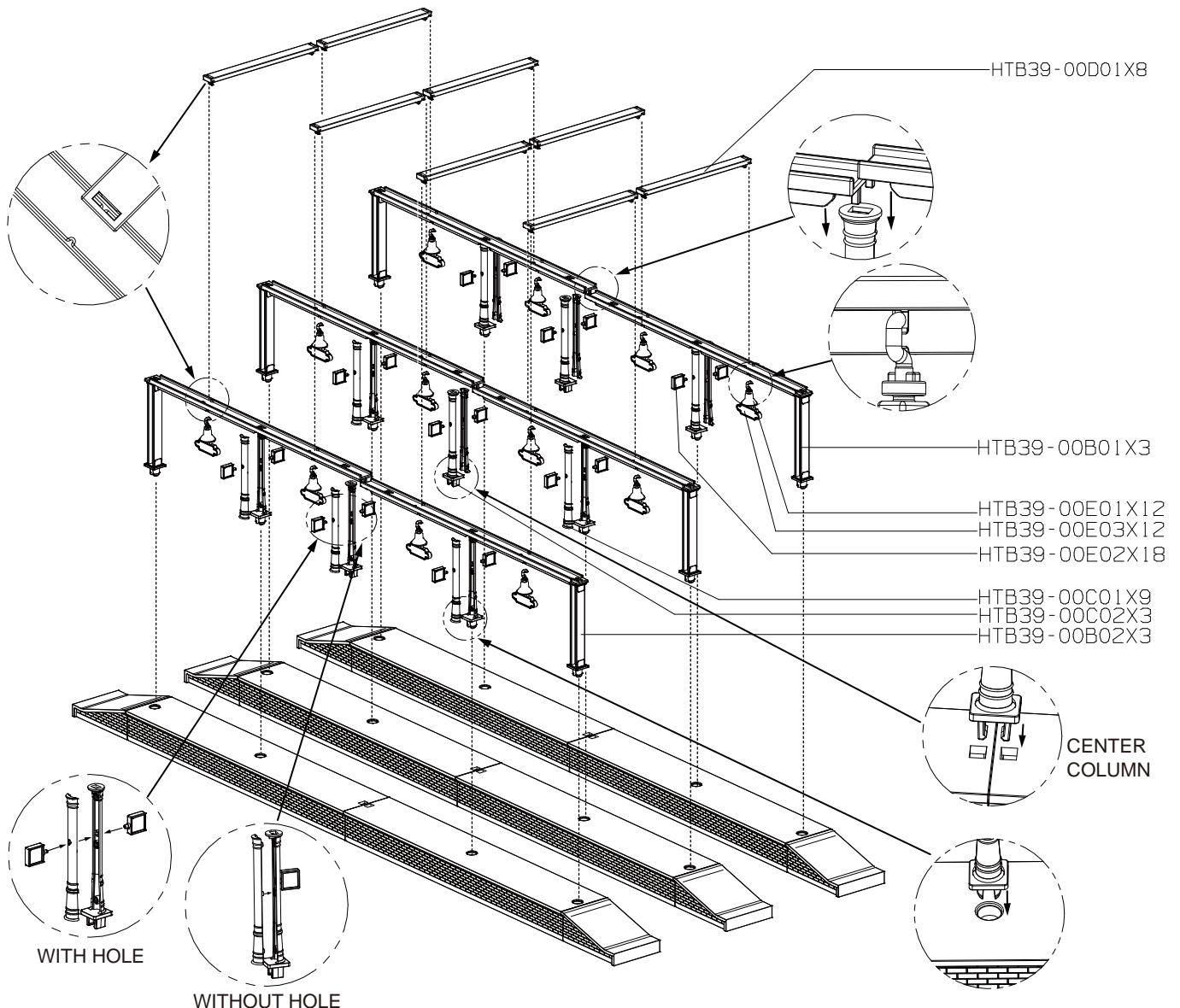

Make sure open sides (without added column halves) of external support columns face out from platforms before attaching column structure to platform. Complete using column halves with or without track sign holes as desired (for outside track number signage, attach halves with hole facing outward; for no outside track signage, attach halves without hole facing outward.)

Dome Assembly

Note tab at the end of dome

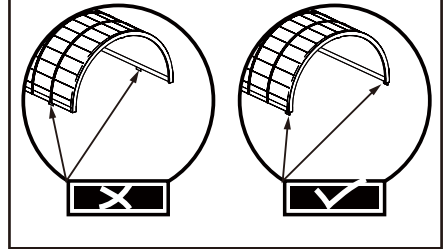

Note 2 different tab positions near ends of domes: at ENDS of domes and SET BACK from ends of domes. Finish dome assembly by sliding ends into position at ENDS WITH TABS.

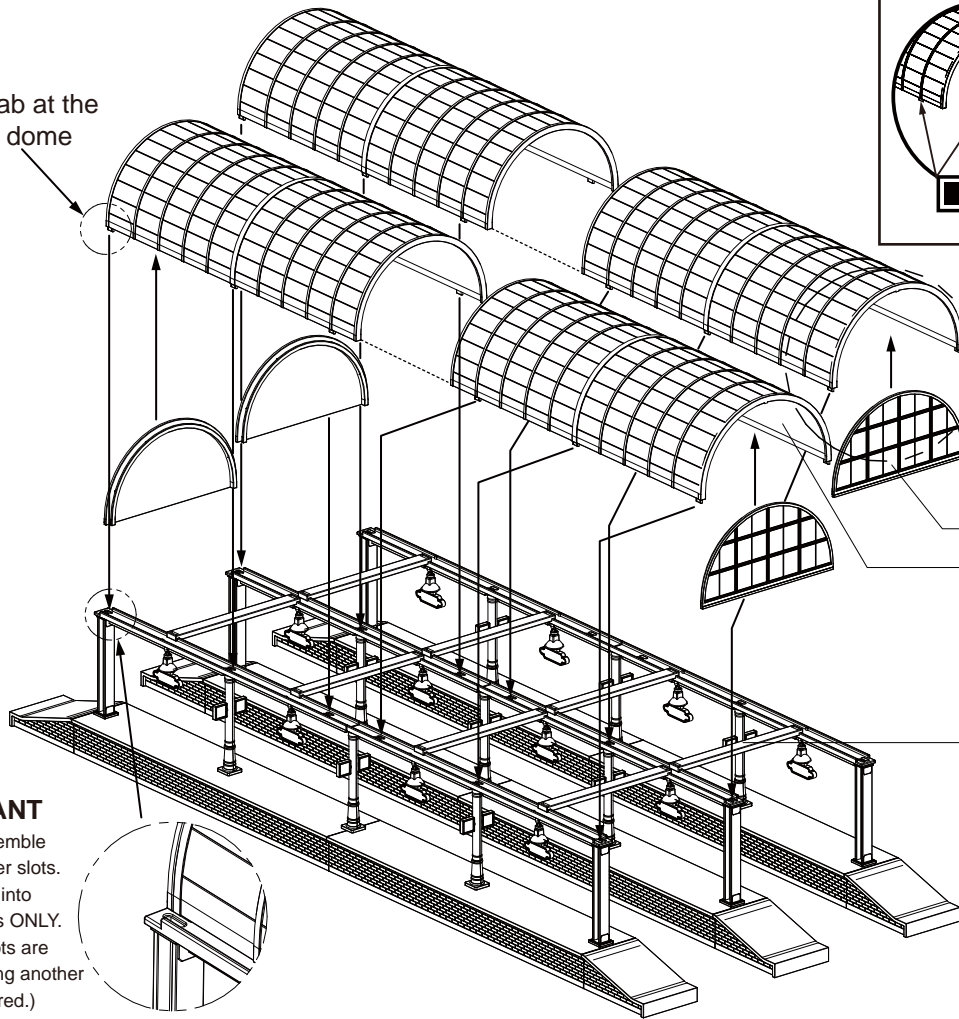

**IMPORTANT**

DO NOT assemble domes in outer slots. Insert domes into inner tab slots ONLY. (Outer tab slots are used for joining another station if desired.)

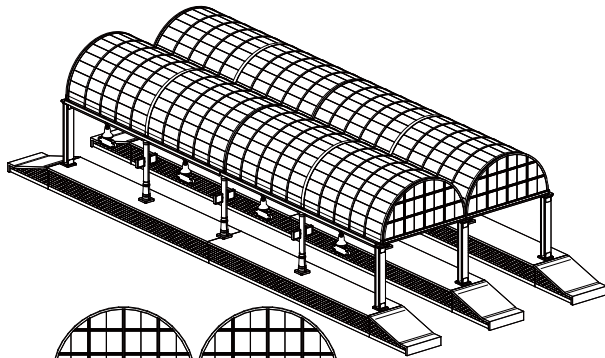
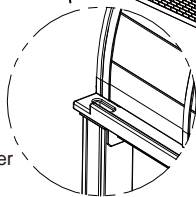

OR

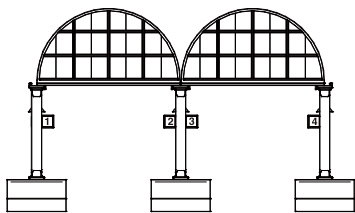

Two joined stations are shown only for illustrative purposes. (Two kits can be combined to make this configuration.)

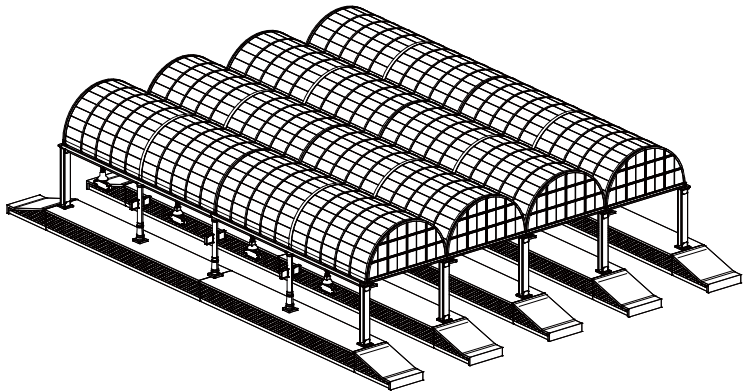

Note: Labels 7-10 needed only if second station added

HTB39-IS001

Direct inquiries to:

Attention: Service Department  
Bachmann Industries, Inc.  
1400 East Erie Avenue  
Philadelphia, PA 19124  
USA

Telephone: 800-356-3910 (toll free within the United States and Canada only)  
Telephone: 215-533-1600 (for all countries)

E-mail: [service@bachmanntrains.com](mailto:service@bachmanntrains.com)

Printed in China

Demande de renseignements à :

Service d'entretien  
Bachmann Industries, Inc.  
1400 East Erie Avenue  
Philadelphia, PA 19124  
É.-U.

Téléphone : 1 800 356-3910 (sans frais aux États-Unis et au Canada seulement)  
Téléphone : 1 (215) 533-1600 (pour tous les pays)

Courriel : [service@bachmanntrains.com](mailto:service@bachmanntrains.com)

Impresso en China

Dome Assembly

Note tab at the end of dome

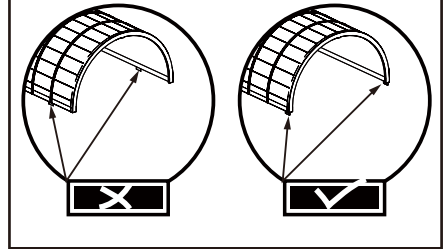

Note 2 different tab positions near ends of domes: at ENDS of domes and SET BACK from ends of domes. Finish dome assembly by sliding ends into position at ENDS WITH TABS.

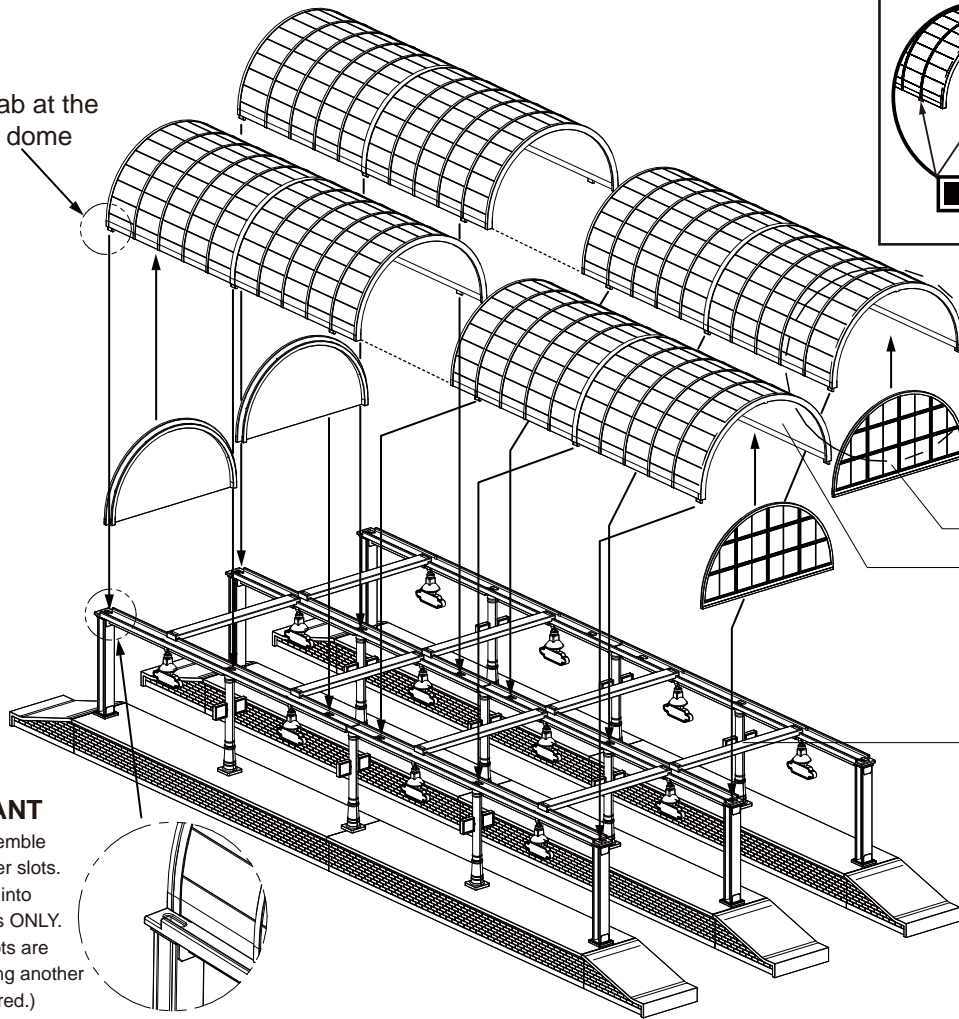

**IMPORTANT**

DO NOT assemble domes in outer slots. Insert domes into inner tab slots ONLY. (Outer tab slots are used for joining another station if desired.)

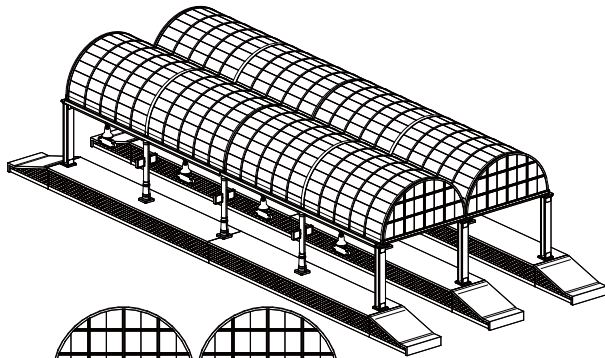
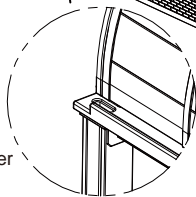

OR

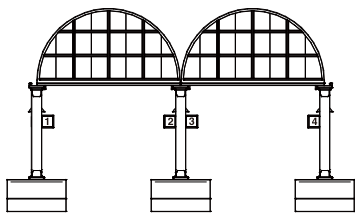

Two joined stations are shown only for illustrative purposes. (Two kits can be combined to make this configuration.)

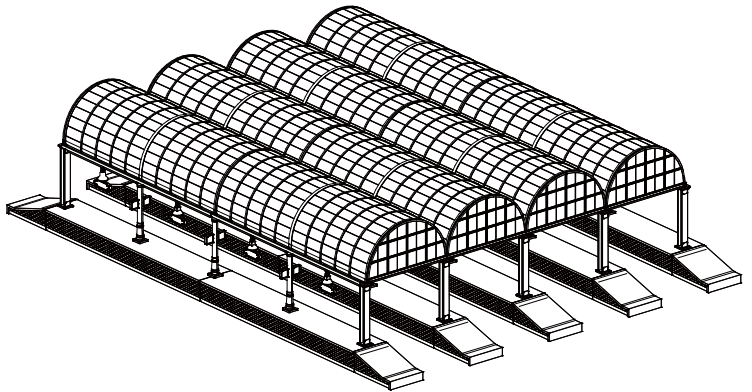

Note: Labels 7-10 needed only if second station added

HTB39-IS001

Direct inquiries to:

Attention: Service Department  
Bachmann Industries, Inc.  
1400 East Erie Avenue  
Philadelphia, PA 19124  
USA

Telephone: 800-356-3910 (toll free within the United States and Canada only)  
Telephone: 215-533-1600 (for all countries)

E-mail: [service@bachmanntrains.com](mailto:service@bachmanntrains.com)

Printed in China

Demande de renseignements à :

Service d'entretien  
Bachmann Industries, Inc.  
1400 East Erie Avenue  
Philadelphia, PA 19124  
É.-U.

Téléphone : 1 800 356-3910 (sans frais aux États-Unis et au Canada seulement)  
Téléphone : 1 (215) 533-1600 (pour tous les pays)

Courriel : [service@bachmanntrains.com](mailto:service@bachmanntrains.com)

Impresso en China